

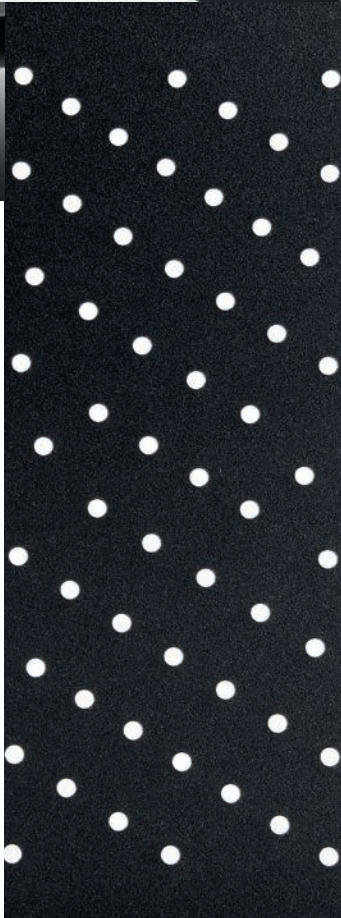

BEYOND **Design**

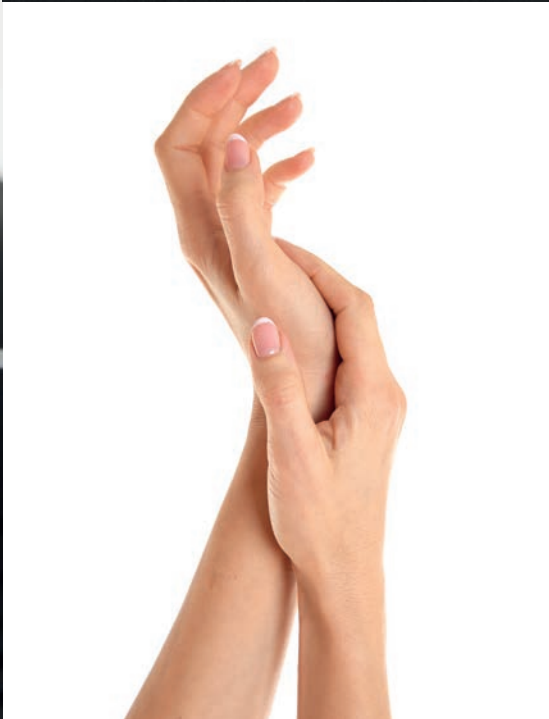



nexus



nexus

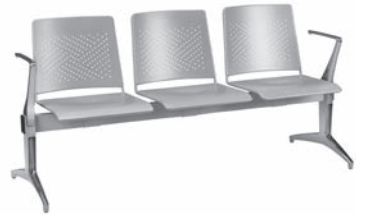

slide

4 legs

bench



EN 16139



EN 16139

nexus showing

tools



configurator



certification



brochure



video

features



designed by:
**esedra &
alessandrocrosera&partners**



trolley
available

La panca interamente in metallo.

Un pezzo unico, dal design essenziale, che garantisce una seduta comoda e molto stabile. Completano la famiglia i telai impilabili 4 gambe e slitta.

Plus:

- struttura innovativa, sviluppata in un unico pezzo e interamente in metallo;
- design distintivo, grazie soprattutto alla scocca traforata, interamente in metallo e disponibile in 4 finiture;
- funzionale e facile da pulire;
- qualità certificata CATAS.

Nexus è ideale per tutti gli **ambienti Community e Le Waiting Area**.

The all-metal bench.

A unique piece, with an essential design, which guarantees a comfortable and very stable seat. The family is completed by the stackable 4-legged and sled frames.

Advantages:

- innovative structure, developed in one piece and entirely in metal;
- distinctive design, thanks above all to the perforated seat shell, made entirely in metal and available in 4 finishes;
- functional and easy to clean;
- CATAS certified quality.

Nexus is ideal for all Community environments and Waiting Areas.



nexus

bench

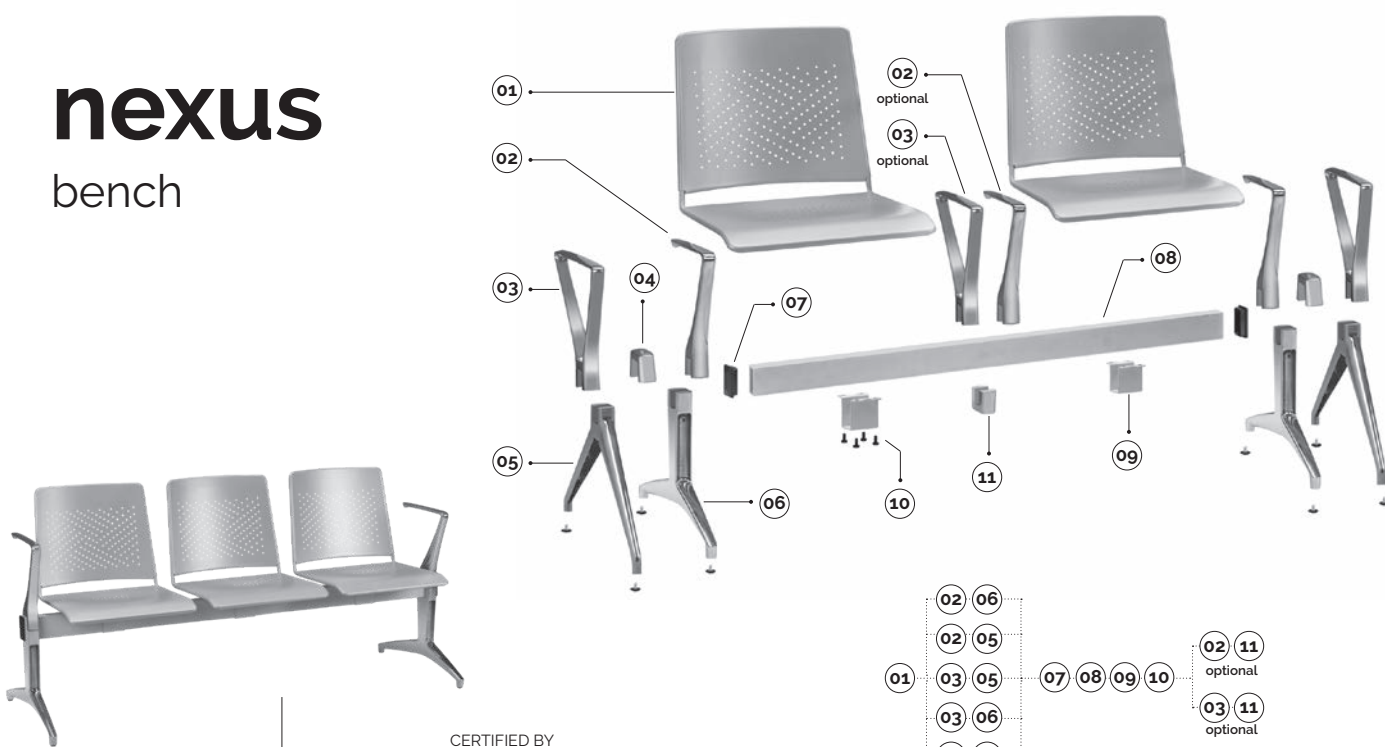

CERTIFIED BY
CATAS

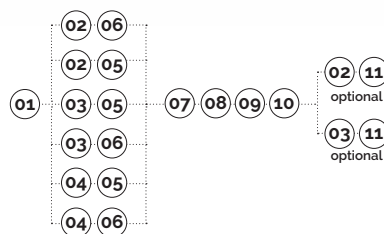

Corten • *Specifica caratteristica del Corten è la variabilità nella tonalità della finitura.
* A specific characteristic of Corten is the variability in the tone of the finish.

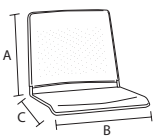

01



02

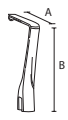

03

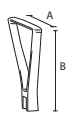

04

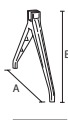

05

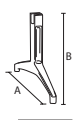

06

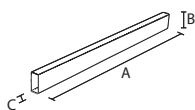

08



09



11

01 nexus-scocca in lamiera
nexus-shell metal sheet

code	finishing	q.kit	q.pack	a	b	c	kg.x1	vol.x1
110703-220	● nero/black	x1	60	405	454	545	7,60	mc. 0.02
110704-220	● grigio/grey	x1	60	405	454	545	7,60	mc. 0.02
110705-220	○ bianco/white ral9010	x1	60	405	454	545	7,60	mc. 0.02
110707-220	● corten*	x1	60	405	454	545	7,60	mc. 0.02

02 cut-braccioletto in alluminio per panca + n'2 viti
cut-aluminium arm for bench + n'2 screws

code	finishing	q.kit	q.pack	a	b	kg.x1	vol.x1
111704-223	● alluminio/aluminium	x1	10	300	305	1,40	mc. 0.0011

03 slim-braccioletto in alluminio per panca + n'2 viti
slim-aluminium arm for bench + n'2 screws

code	finishing	q.kit	q.pack	a	b	kg.x1	vol.x1
111704-225	● alluminio/aluminium	x1	10	325	305	1,40	mc. 0.0011

04 cut/slim-cavallotto in alluminio per gamba panca + n'2 viti
cut/slim-aluminium bracket 80x40 for bench leg + n'2 screws

code	finishing	q.kit	q.pack	a	b	kg.x1	vol.x1
111704-222	● alluminio/aluminium	x1	10	60	95	0,40	mc. 0.0012

05 slim-gamba in alluminio per gamba panca + n'2 piedini
slim-aluminium leg for bench + n'2 glides

code	finishing	q.kit	q.pack	a	b	kg.x1	vol.x1
111704-226	● alluminio/aluminium	x2	5	610	350	1,20	mc. 0.014

06 cut-gamba in alluminio per gamba panca + n'2 piedini
cut-aluminium leg for bench + n'2 glides

code	finishing	q.kit	q.pack	a	b	kg.x1	vol.x1
111704-224	● alluminio/aluminium	x2	5	610	350	2,55	mc. 0.014

07 tappo copritesta rettangolare 80x40 nero
rectangular cover head cap 80x40 black

code	finishing	q.kit
134103-001	● nero/black	x2

08 got(03) trave per panca 80x40
got(03) beam for bench 80x40

code	finishing	q.kit	q.pack	a	b	c	kg.x1	vol.x1
110703-190	● nero/black	2 posti / 2 seats	x1	1	1160	80	40	3,20 mc. 0.0045
110704-090	● grigio/grey	2 posti / 2 seats	x1	1	1160	80	40	3,20 mc. 0.0045
110703-191	● nero/black	3 posti / 3 seats	x1	1	1710	80	40	4,71 mc. 0.005
110704-091	● grigio/grey	3 posti / 3 seats	x1	1	1710	80	40	4,71 mc. 0.005
110703-192	● nero/black	4 posti / 4 seats	x1	1	2260	80	40	6,22 mc. 0.0085
110704-092	● grigio/grey	4 posti / 4 seats	x1	1	2260	80	40	6,22 mc. 0.0085
110703-193	● nero/black	5 posti / 5 seats	x1	1	2800	80	40	7,72 mc. 0.01
110704-193	● grigio/grey	5 posti / 5 seats	x1	1	2800	80	40	7,72 mc. 0.01

09 90cv-cavallotto sotto trave
90cv-support under beam

code	finishing	q.kit	q.pack	a	b	kg.x1	vol.x1
110703-007	● nero/black	x1	50	55	65	0,60	mc. 0.0005
110704-016	● grigio/grey	x1	50	55	65	0,60	mc. 0.0005

10 confezione viti m8x12 testa cilindrica a esagono incassato brunita nera
screws m8x12 cylindrical head hexagon embedded burnishing black package

code	finishing	q.kit	q.pack
117003-070	● nero/black	x4	200

11 cut/slim-cavallotto in alluminio per bracciolo panca
cut/slim-aluminium bracket 80x40 for bench arm

code	finishing	q.kit	q.pack	a	b	kg.x1	vol.x1
111704-221	● alluminio/aluminium	x1	10	58	95	0,32	mc. 0.0012

main component sizes

for the bench components, see page 249

nexus

bench leg options

• optional

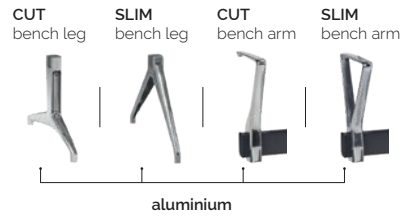
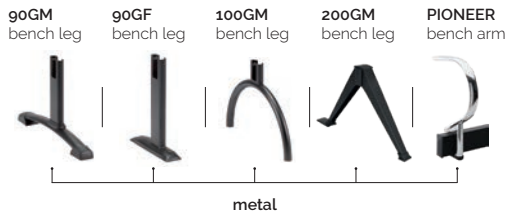
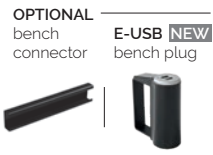

bench sizes

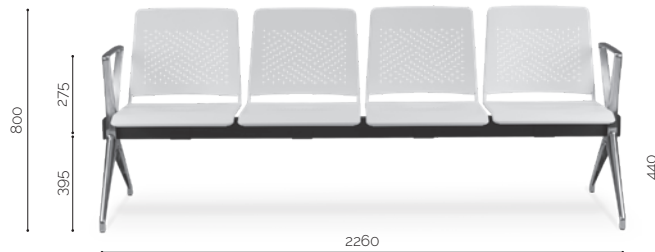
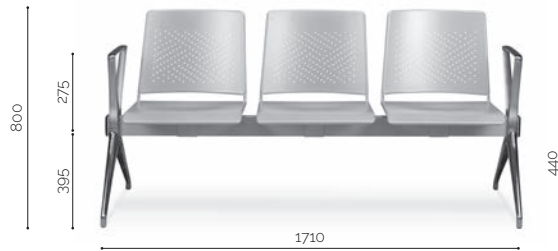
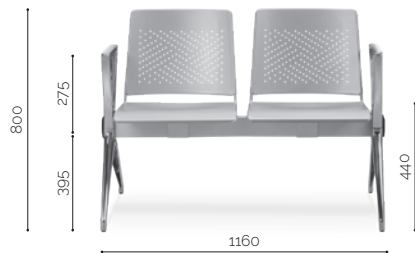

nexus

bench

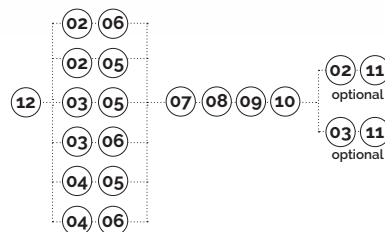
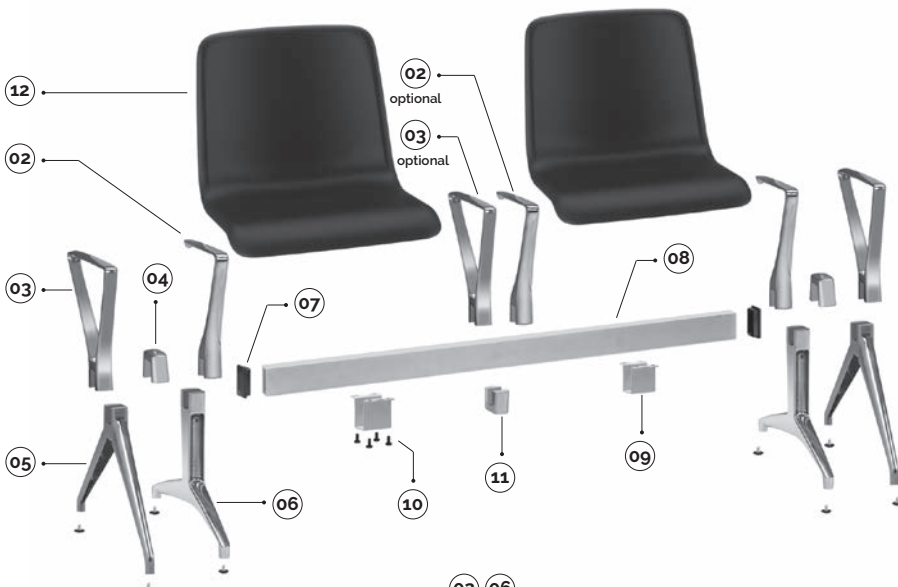

Disponibile in diversi colori mono/bi-colour per lotti da 100 pezzi

Available in different colours mono/bi-colour for batches from 100 pcs

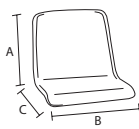

12



04



03



04

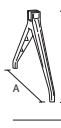

05

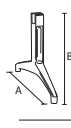

06

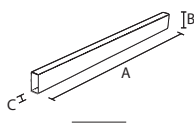

07

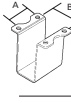

08

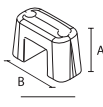

09



11

main component sizes

12 **nexus-scocca in poliuretano morbido freeform advanced**
nexus-half-soft polyurethane freeform advanced shell model

code	finishing	q.kit	q.pack	a	b	c	kg.x1	vol.x1
133903-061	● nero/black	x1		410	485	430	7,60	mc. 0.09

02 **cut-bracciolo in alluminio per panca + n'2 viti**
cut-aluminium arm for bench + n'2 screws

code	finishing	q.kit	q.pack	a	b	kg.x1	vol.x1
111704-223	● alluminio/aluminium	x1	10	300	305	1,40	mc. 0.0011

03 **slim-bracciolo in alluminio per panca + n'2 viti**
slim-aluminium arm for bench + n'2 screws

code	finishing	q.kit	q.pack	a	b	kg.x1	vol.x1
111704-225	● alluminio/aluminium	x1	10	325	305	1,40	mc. 0.0011

04 **cut/slim-cavallotto in alluminio per gamba panca + n'2 viti**
cut/slim-aluminium bracket 80x40 for bench leg + n'2 screws

code	finishing	q.kit	q.pack	a	b	kg.x1	vol.x1
111704-222	● alluminio/aluminium	x1	10	60	95	0,40	mc. 0.0012

05 **slim-gamba in alluminio per gamba panca + n'2 piedini**
slim-aluminium leg for bench + n'2 glides

code	finishing	q.kit	q.pack	a	b	kg.x1	vol.x1
111704-226	● alluminio/aluminium	x2	5	610	350	1,20	mc. 0.014

06 **cut-gamba in alluminio per gamba panca + n'2 piedini**
cut-aluminium leg for bench + n'2 glides

code	finishing	q.kit	q.pack	a	b	kg.x1	vol.x1
111704-224	● alluminio/aluminium	x2	5	610	350	2,55	mc. 0.014

07 **tappo copritesta rettangolare 80x40 nero**
rectangular cover head cap 80x40 black

code	finishing	q.kit
134103-001	● nero/black	x2

08 **got(03) trave per panca 80x40**
got(03) beam for bench 80x40

code	finishing		q.kit	q.pack	a	b	c	kg.x1	vol.x1
110703-190	● nero/black	2 posti / 2 seats	x1	1	1160	80	40	3,20	mc. 0.0045
110704-090	● grigio/grey	2 posti / 2 seats	x1	1	1160	80	40	3,20	mc. 0.0045
110703-191	● nero/black	3 posti / 3 seats	x1	1	1710	80	40	4,71	mc. 0.005
110704-091	● grigio/grey	3 posti / 3 seats	x1	1	1710	80	40	4,71	mc. 0.005
110703-192	● nero/black	4 posti / 4 seats	x1	1	2260	80	40	6,22	mc. 0.0085
110704-092	● grigio/grey	4 posti / 4 seats	x1	1	2260	80	40	6,22	mc. 0.0085
110703-193	● nero/black	5 posti / 5 seats	x1	1	2800	80	40	7,72	mc. 0.01
110704-193	● grigio/grey	5 posti / 5 seats	x1	1	2800	80	40	7,72	mc. 0.01

09 **gocv-cavallotto sotto trave**
gocv-support under beam

code	finishing	q.kit	q.pack	a	b	kg.x1	vol.x1
110703-007	● nero/black	x1	50	55	65	0,60	mc. 0.0005
110704-016	● grigio/grey	x1	50	55	65	0,60	mc. 0.0005

10 **confezione viti m8x12 testa cilindrica a esagono incassato brunita nera**
screws m8x12 cylindrical head hexagon embedded burnishing black package

code	finishing	q.kit	q.pack
117003-070	● nero/black	x4	200

11 **cut/slim-cavallotto in alluminio per bracciolo panca**
cut/slim-aluminium bracket 80x40 for bench arm

code	finishing	q.kit	q.pack	a	b	kg.x1	vol.x1
111704-221	● alluminio/aluminium	x1	10	58	95	0,32	mc. 0.0012

for the bench components, see page 249

nexus

4-legs

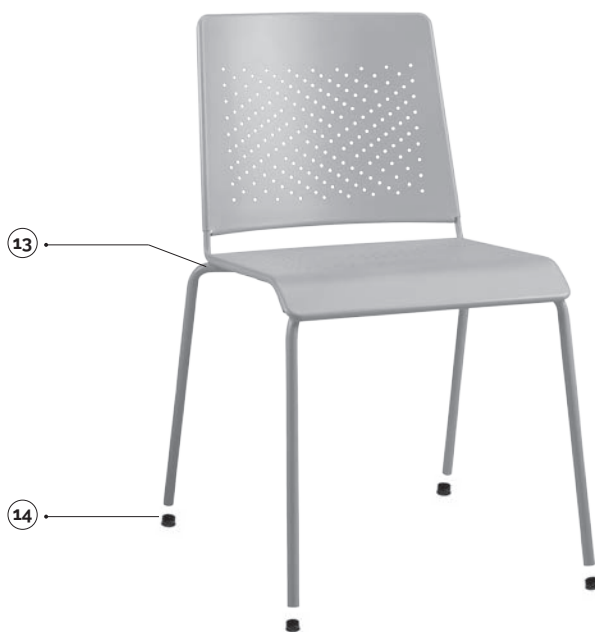

Corten *Specifica caratteristica del Corten è la variabilità nella tonalità della finitura.
* A specific characteristic of Corten is the variability in the tone of the finish.

13 14

main component sizes

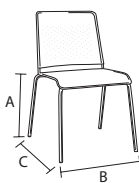

13

13 nexus-telaio 4 gambe con scocca in lamiera
nexus-4 legs frame with shell metal sheet

code	finishing	q.kit	q.pack	a	b	c	kg.x1	vol.x1
112603-070	● nero/black	x1	50	450	530	540	9,80	mc. 0,04
112604-070	● grigio/grey	x1	50	450	530	540	9,80	mc. 0,04
112605-070	○ bianco/white ral9010	x1	50	450	530	540	9,80	mc. 0,04
112607-070	● corten*	x1	50	450	530	540	9,80	mc. 0,04

14 puntale alettato tondo d.18 nero
inner cap for legs d.18 black

code	finishing	q.kit	q.pack
137003-072	● nero/black	x4	200



nexus-carrello portasedie con accessori nero
nexus-trolley for chairs with accessories black

code	finishing	q.kit
110803-342	● nero/black	x1

nexus

slide

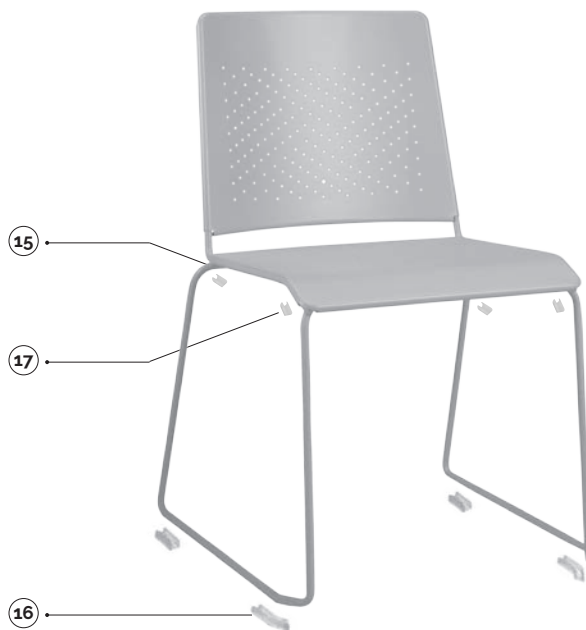

Corten
 • *Specifica caratteristica del Corten è la variabilità nella tonalità della finitura.
 • *A specific characteristic of Corten is the variability in the tone of the finish.

15 16 17

main component sizes

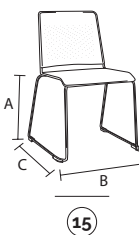

15

15 nexus-telaio slitta in tondino con scocca in lamiera
 nexus-slide wire frame with shell metal sheet

code	finishing	q.kit	q.pack	a	b	c	kg.x1	vol.x1
113403-010	● nero/black	x1	50	450	520	565	8,20	mc. 0,04
113404-010	● grigio/grey	x1	50	450	520	565	8,20	mc. 0,04
113405-010	○ bianco/white ral9010	x1	50	450	520	565	8,20	mc. 0,04
113407-010	● corten*	x1	50	450	520	565	8,20	mc. 0,04

16 btf-kit piedini
 btf-kit feet

code	finishing	q.kit	q.pack	kg.x1
134306-001	○ neutro/neutral	x1	100	0,05

17 confezione di basi a pinza antirotazione per tondino colore neutro
 neutral clips base for wire d.11 package

code	finishing	q.kit	q.pack
137006-070	○ neutro/neutral	x4	200

optional



16



17

