

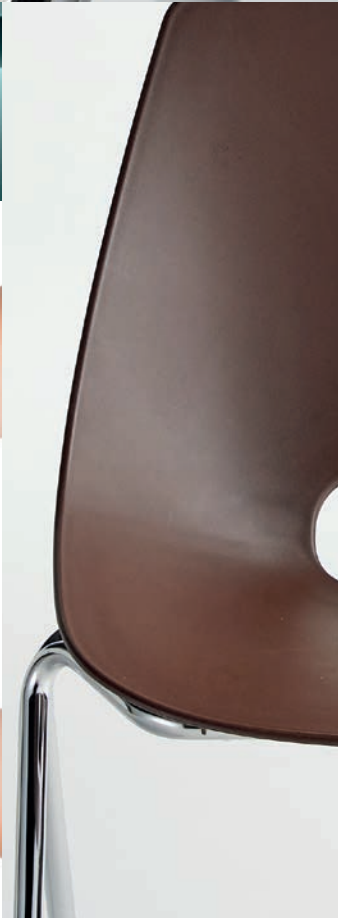

BEYOND | **Logistic**





**oki**



# oki



---

slide

4 legs

swivel

bench

4 legs w/armrests

4 legs w/writing tablet

oki showing

---



Una sedia dalla **monoscocca in plastica ampia, confortevole** e dai colori vivaci che, unitamente all'ampio foro centrale, le conferiscono un **look casual** e pratico. È inoltre impilabile e facile da pulire.

Con l'ampia gamma di telai previsti, disponibili in varie finiture, può adattarsi a diverse finalità **dall'Home all'Office**, fino alle **aree Community** grazie al telaio in tubo con aggancio laterale, ai braccioli e al porta tavoletta.

*A **large, comfortable monocoque plastic** chair available in range of bright colours which, together with the large central hole, go to create **casual and practical look**. It is also stackable and easy to clean.*

*With the wide range of frames available in a selection of finishes, it can be adapted to different contexts, ranging from **Home to Office**, and even **Community areas** thanks to the tubular frame with lateral hooks, armrests, and writing tablet holder.*

# oki

## slide

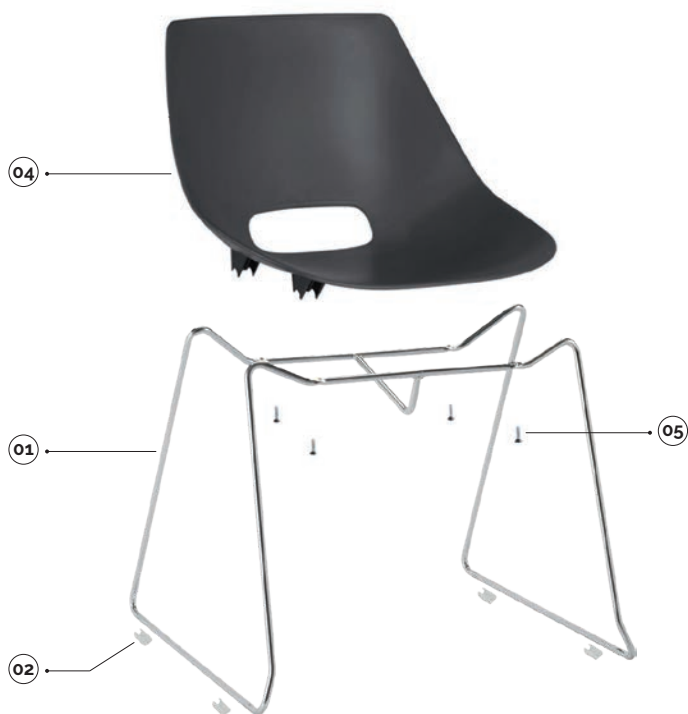

plastic colours

- nero/black
- bianco/white 218
- blu/blue 5002

main component sizes

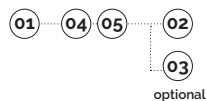
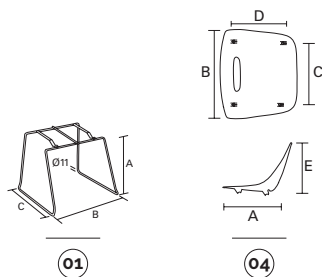

**01** oki-sgabello in tondino per scocca cromato senza tappi  
oki-stool in chrome frame wire for shell without caps

code	finishing	q.kit	q.pack	a	b	c	kg.x1	vol.x1
113410-008	● cromato/chrome	x1	50	450	600	550	3,30	mc. 0,04

**02** confezione di basi a pinza antirotazione per tondino colore neutro  
neutral clips base for wire d.11 package

code	finishing	q.kit	q.pack
137006-070	○ neutro/neutral	x4	200

**03** base piana a pinza doppia in pe per tondo per unione sedie  
double flat clip base for tube

code	finishing	q.kit
134006-021	○ neutro/neutral	x4

**04** oki-scocca intera modello oki  
oki-shell for oki model

code	finishing	q.kit	q.pack	a	b	c	d	e	kg.x1	vol.x1
133903-050	● nero/black	x1	10	525	530	209	306	395	1,80	mc. 0,025

**05** vite autoflettante 5,5x19 testa cilindrica a croce zincata (vite fissaggio scocca)  
auto-thread screw 5,5x19 cylindrical head cross zinc (screw for shell fixing)

code	finishing	q.kit
117811-180	○ zincata/zinc	x4

optional

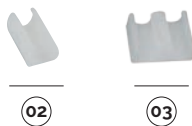

for all colour codes, see page 123

# oki

## 4-legs



plastic colours

- nero/black
- bianco/white 218
- blu/blue 5002

main component sizes

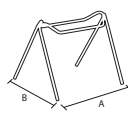

06

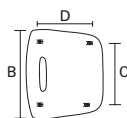

04



optipnats

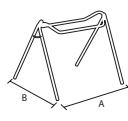

10



### 06 oki-sgabello 4 gambe in tubo d.18 senza tappi oki-4 legs stool d.18 tube without caps

code	finishing	q.kit	q.pack	a	b	kg.x1	vol.x1
112703-090	● nero/black	x1	100	560	520	2,70	mc. 0,02
112704-090	● grigio/grey	x1	100	560	520	2,70	mc. 0,02
112710-090	● cromato/chrome	x1	100	560	520	2,70	mc. 0,02

### 07 tappi-puntale alettato testa sferica d.18 nero inner caps-black spherical cap d.18

code	finishing	q.kit
134203-181	● nero/black	x4

### 08 confezione viti hilo d.5x35 testa svasata a croce zincate (vite fissaggio scocca) screws auto-thread 5x35 flared cross head zinc for shell fixing package

code	finishing	q.kit	q.pack
117011-070	○ zincata/zinc	x4	200

### 04 oki-scocca intera modello oki oki-shell for oki model

code	finishing	q.kit	q.pack	a	b	c	d	e	kg.x1	vol.x1
133905-050	○ bianco/white 218	x1	10	525	530	209	306	395	1,80	mc. 0,025

### 09 supporto per impilabilita' scocca oki neutro support for stackability neutral shell oki

code	finishing	q.kit
134006-031	○ neutro/neutral	x1

### 10 oki-sgabello 4 gambe in tubo d.18 con aggancio laterale senza tappi oki-4 legs stool d.18 tube with lateral hooks without caps

code	finishing	q.kit	q.pack	a	b	kg.x1	vol.x1
112703-091	● nero/black	x1	100	560	520	2,70	mc. 0,02
112704-091	● grigio/grey	x1	100	560	520	2,70	mc. 0,02
112710-091	● cromato/chrome	x1	100	560	520	2,70	mc. 0,02

frame optional  
4 legs stool d.18 tube with lateral hooks

10

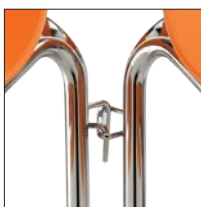

for all colour codes, see page 123

# oki

4-legs w/armrests



plastic colours

- nero/black
- bianco/white 218
- blu/blue 5002

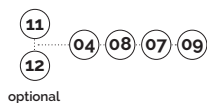

main component sizes

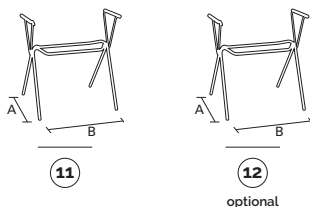

**11** oki-sgabello 4 gambe in tubo d.18 con braccioli senza tappi  
oki-4 legs stool with armrest d.18 tube without caps

code	finishing	q.kit	q.pack	a	b	kg.x1	vol.x1
112703-096	● nero/black	x1	50	560	520	4,00	mc. 0,05
112704-096	● grigio/grey	x1	50	560	520	4,00	mc. 0,05
112710-096	● cromato/chrome	x1	50	560	520	4,00	mc. 0,05

**12** oki-sgabello 4 gambe tubo d.18 con braccioli + aggancio portatavoletta senza tappi  
oki-4 legs stool with armrest d.18 tube without caps + hook for tablet

code	finishing	q.kit	q.pack	a	b	kg.x1	vol.x1
112703-098	● nero/black	x1	50	560	520	4,00	mc. 0,05
112704-098	● grigio/grey	x1	50	560	520	4,00	mc. 0,05
112710-098	● cromato/chrome	x1	50	560	520	4,00	mc. 0,05

for the components below, see page 119



for all colour codes, see page 123

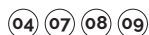

for writing tablet options, see page 192/193

# oki

## swivel



plastic colours

- nero/black
- bianco/white 218
- blu/blue 5002

main component sizes

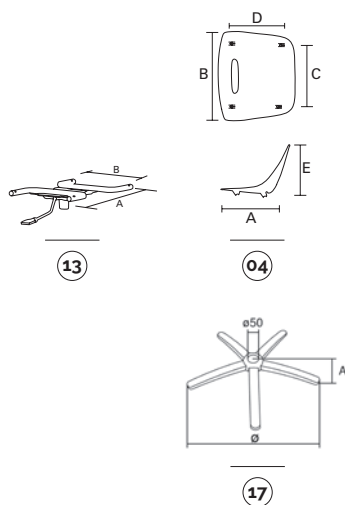

optipnats

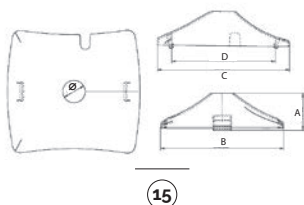

13 04 08 14 15 17  
optional

**13** oki-supporto girevole a gas per scocca oki  
oki-gas lift swivel metal frame for oki shell

code	finishing	q.kit	q.pack	a	b	kg.x1	vol.x1
110903-010	● nero/black	x1	10	306	209	1,30	mc. 0.04

**14** confezione tappi copritesta d.18 neri  
black cover head caps d.18 package

code	finishing	q.kit	q.pack
137003-070	● nero/black	x4	200

**04** oki-scocca intera modello oki  
oki-shell for oki model

code	finishing	q.kit	q.pack	a	b	c	d	e	kg.x1	vol.x1
133915-050	● blu/blue 5002	x1	10	525	530	209	306	395	1,80	mc. 0.025

**08** confezione viti hilo d.5x35 testa svasata a croce zincate (vite fissaggio scocca)  
screws auto-thread 5x35 flared cross head zinc for shell fixing package

code	finishing	q.kit	q.pack
117011-070	○ zincata/zinc	x4	200

**15** cpg-copertina in plastica per telaio girevole  
cpg-plastic cover for swivel frame

code	finishing	q.kit	q.pack	a	b	c	d	ø	kg.x1	vol.x1
130903-000	● nero/black	x1	50	60	200	210	167	36	0,1	mc. 0.0015

**17** b40 base in metallo d.640 con coprisaldatura  
b40 metal base d.640 with cover welding

code	finishing	q.kit	q.pack	a	ø	kg.x1	vol.x1
110210-027	● cromato/chrome	x1	5	60	640	2,85	mc. 0.014

CPG  
plastic cover for swivel frame



for all colour codes, see page 123



# oki

## bench



plastic colours

- nero/black
- bianco/white 218
- blu/blue 5002

16 04 08 14

**16** oki-supporto per attacco scocca oki su panca  
smile-bench frame for oki shell

code	finishing	q.kit	q.pack	a	b	kg.x1	vol.x1
110703-053	● nero/black	x1	15	306	209	1.40	mc. 0.004

main component sizes

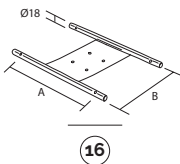

for the components below, see page 121

04 08 14



for all colour codes, see page 123

for the bench components, see page 201

optionals

OPTIONAL  
bench  
connector



E-USB **NEW**  
bench plug



JIM **NEW**  
bench leg



APOLL  
bench arm



plastic

90GM  
bench leg



90GF  
bench leg



100GM  
bench leg



200GM  
bench leg



PIONEER  
bench arm



metal

CUT  
bench leg



SLIM  
bench leg



CUT  
bench arm



SLIM  
bench arm



aluminium

# oki

optional colour codes



## shell colour codes



04 scocca in plastica  
plastic shells

- 133903-050 nero/black
- 133905-050 bianco/white 218
- 133915-050 blu/blue 5002

