



square



square



slide
slide w/armrests

4 legs
4 legs w/armrest
4 legs w/writing tablet

4 legs with castors
4 legs with castors w/armrest

swivel
swivel w/armrest

bench
bench w/armrest



EN 13761



EN 16139



BIFMA TEST

tools

square showing



certification

features



trolley available



designed by:
r&d albacomponents



La sedia versatile e caratterizzante.

Ampla e confortevole, funzionale a utilizzi diversi, prevede schienale e sedile in diverse varianti: da tappezzare, in plastica a vista, con possibili pannellini da tappezzare, in multistrato faggio verniciato. Grazie alle numerose opzioni e versioni di telai disponibili, si adatta a molteplici utilizzi.

Plus:

- telaio con sezione del tubo rettangolare che la contraddistingue sul mercato;
- seduta ampia e confortevole;
- massima versatilità
- qualità certificata CATAS.

Square è indicata per l'ambiente Office e l'ambiente Contract.

A versatile and distinctive chair.

A generous, comfortable and functional chair making it ideal for diverse settings. Available in a range of backrest and seat variations: to be upholstered, in bare plastic, with the possibility of including a seat pad to be upholstered, in varnished beech plywood. Thanks to the large number of options and frame versions available, Square is suitable for multiple uses.

Advantages:

- frame with highly distinctive rectangular-section tube;
- features a generous, comfortable seat;
- maximum versatility;
- CATAS certified quality.

Square is suitable for Office and the Contract environments.

square

4-legs



CERTIFIED BY
**BIFMA
CATAS**

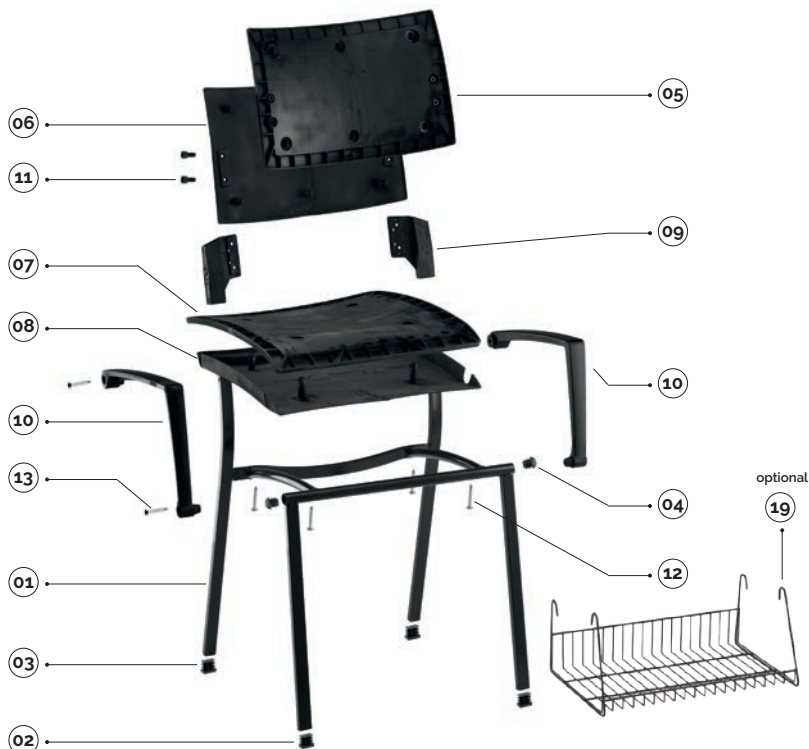

square-carrello portasedie con accessori
square-trolley for chairs with accessories

code	finishing	q.kit
110803-371	● nero/black	x1

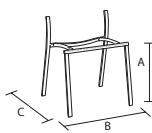
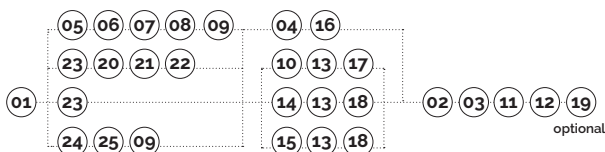

01

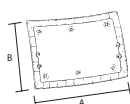

05

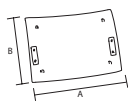

06

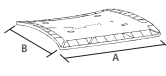

07

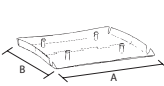

08

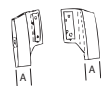

09

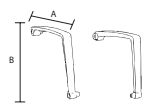

10

main component sizes

optionals

01 square-telaio per sedia fissa senza tappi sottopiede montati
square-fixed frame for chair without caps

code	finishing	q.kit	q.pack	a	b	c	kg.x1	vol.x1
112603-025	● nero/black	x1	80	450	500	500	3,20	mc. 0,003
112604-025	● grigio/grey	x1	80	450	500	500	3,20	mc. 0,003
112610-025	● cromato/chrome	x1	80	450	500	500	3,20	mc. 0,003

02 confezione puntali rettangolari 25x15
black inner flat rectangular caps 25x15 package

code	finishing	q.kit	q.pack
137003-074	● nero/black	x2	160
134204-020	● grigio/grey	x2	

*forniti nella stessa confezione
supplied in the same package

03 confezione puntali inclinati rettangolari 25x15
black inner oblique rectangular caps 25x15 package

code	finishing	q.kit	q.pack
137003-074	● nero/black	x2	160
134204-023	● grigio/grey	x2	

*forniti nella stessa confezione
supplied in the same package

04 tappo copritesta 022 per sedia senza braccioli
cover head cap 022 for chair without arms

code	finishing	q.kit
134103-220	● nero/black	x2
134104-220	● grigio/grey	x2

05 square-shi-schienale interno in plastica
square-shi-inner plastic back

code	finishing	q.kit	q.pack	a	b	kg.x1	vol.x1
132103-006	● nero/black	x1	20	440	290	0,55	mc. 0,004

06 square-she-schienale esterno in plastica
square-she-outer plastic back

code	finishing	q.kit	q.pack	a	b	kg.x1	vol.x1
132103-005	● nero/black	x1	20	425	280	0,37	mc. 0,004
132104-026	● grigio/grey	x1	20	425	280	0,37	mc. 0,004

07 square-sedile interno in plastica
square-inner plastic seat

code	finishing	q.kit	q.pack	a	b	kg.x1	vol.x1
132203-007	● nero/black	x1	20	440	460	0,90	mc. 0,005

08 square-sedile esterno in plastica
square-outer plastic seat

code	finishing	q.kit	q.pack	a	b	kg.x1	vol.x1
132203-006	● nero/black	x1	20	430	450	0,53	mc. 0,008
132204-026	● grigio/grey	x1	20	430	450	0,53	mc. 0,008

09 square-coppia supporti schienale in plastica
square-plastic pair of supports for back

code	finishing	q.kit	q.pack	a	kg.x1	vol.x1
134003-087	● nero/black	x1	40	25x15	0,16	mc. 0,0002
134004-022	● grigio/grey	x1	40	25x15	0,16	mc. 0,0002

10 square-coppia braccioli in plastica
square-plastic pair arms

code	finishing	q.kit	q.pack	a	b	kg.x1	vol.x1
131703-005	● nero/black	x1	10	360	260	0,70	mc. 0,006
131704-005	● grigio/grey	x1	10	360	260	0,70	mc. 0,006

19 square-cestello portariviste
square-basket tray

code	finishing	q.kit
113403-003	● nero/black	x1

11 vite testa cilindrica a croce m6x16 zincata
screw cylindrical cross head m6x16 zinc

code	finishing	q.kit
117711-191	○ zincata/zinc	x4

12 vite testa svasata a croce m6x30 zincata (vite per fissaggio sedile)
screw flared head m6x30 zinc (screw for six seat)

code	finishing	q.kit
117711-192	○ zincata/zinc	x4

13 vite autofilettante 5,5x45 testa svasata a croce
screw auto-threading 5,5x45 flared cross

code	finishing	q.kit
117811-168	○ zincata/zinc	x4

square

4-legs/tablet and hook options



14

15

14 15 braccio destro/sinistro con gancio portavoletta right/left arm with attachment for tablet

code	finishing		q.kit	q.pack	kg.x1	vol.x1
131703-009	● nero/black	destra/right	x1	20	0,70	mc. 0,006
131703-006	● nero/black	sinistra/left	x1	20	0,70	mc. 0,006
131704-003	● grigio/grey	destra/right	x1	20	0,70	mc. 0,006
131704-004	● grigio/grey	sinistra/left	x1	20	0,70	mc. 0,006

TLT tablet	TLT2 tablet	TLT3 tablet	BEAN tablet	TL02 tablet	SPT2 mechanism tablet	SPTA mechanism antipanic
---------------	----------------	----------------	----------------	----------------	--------------------------	-----------------------------



for writing tablet options, see page 242/243



16

16 17 18 aggancio laterale maschio+femmina in plastica + 2 viti plastic lateral hook male+female and 2 screws

code	finishing		q.kit	q.pack	kg.x1	vol.x1
134003-130	● nero/black		x1	100	0,03	mc. 0,0001
134003-131	● nero/black	per braccio/for arm	x1	100	0,03	mc. 0,0001
134003-138	● nero/black	per braccio con portavoletta/ for arm with attachment for tablet	x1	100	0,03	mc. 0,0001



17

18

4-legs/backrest and seat options

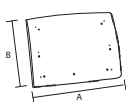

20

22



20 pannello schienale da tappezzare panel back for upholstery

code	finishing		q.kit	q.pack	a	b	kg.x1	vol.x1
132103-046	● nero/black		x1	20	390	310	0,50	mc. 0,004

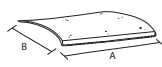

21

21 pannello sedile da tappezzare panel seat for upholstery

code	finishing		q.kit	q.pack	a	b	kg.x1	vol.x1
132203-046	● nero/black		x1	20	400	450	0,60	mc. 0,004

22 confezione viti tbl+ fr. d.5x14 per pannello da tappezzare screws tbl+ fr.hilo d.5x14 zinc.black (to fix seat panel) package

code	finishing		q.kit	q.pack
117003-071	● nero/black		x4	200

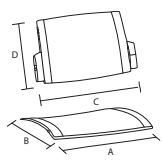

23



23 square-coppia sedile schienale in plastica colorato square-plastic seat/back coloured at sight

code	finishing		q.kit	q.pack	a	b	c	d	kg.x1	vol.x1
134003-088	● nero/black		x1	10	450	440	500	300	1,62	mc. 0,012
134004-023	● grigio/grey	RAL7040	x1	10	450	440	500	300	1,62	mc. 0,012
134002-023	● rosso/red	PPL42	x1	10	450	440	500	300	1,62	mc. 0,012
134015-023	● blu/blue	RAL5002	x1	10	450	440	500	300	1,62	mc. 0,012
134007-023	● arancio/orange	PPL22	x1	10	450	440	500	300	1,62	mc. 0,012
134005-023	● beige/beige	PPL09	x1	10	450	440	500	300	1,62	mc. 0,012

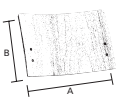

24



24 schienale in multistrato faggio + viti back in plywood beech with screws

code	finishing		q.kit	q.pack	a	b	kg.x1
122107-010	● faggio/beech wood		x1	15	425	280	0,50

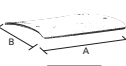

25



25 square sdlf-sedile multistrato faggio verniciato + viti square sdlf-painted beech wood seat with screws

code	finishing		q.kit	q.pack	a	b	kg.x1
122207-015	● faggio/beech wood		x1	15	422	280	1,65

square

4-legs for castors

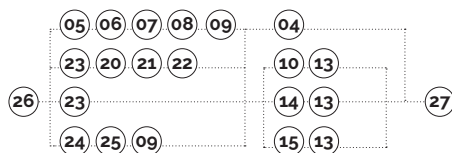

square-carrello portasedie con accessori
square-trolley for chairs with accessories

code	finishing	q.kit
110803-371	● nero/black	x1

26 telaio per sedia 4 gambe predisposto per 4 ruote + 4 tappi porta ruote
frame for chair issued for 4 wheels + 4 inner black caps for castors

code	finishing	q.kit	q.pack	a	b	c	kg.x1	vol.x1
112603-027	● nero/black	x1	80	450	500	500	3,10	mc. 0,003
112604-027	● grigio/grey	x1	80	450	500	500	3,10	mc. 0,003
112610-027	● cromato/chrome	x1	80	450	500	500	3,10	mc. 0,003

04 tappo copritesta 022 per sedia senza braccioli
cover head cap 022 for chair without arms

code	finishing	q.kit
134103-220	● nero/black	x2
134104-220	● grigio/grey	x2

23 square-coppia sedile schienale in plastica colorato
square-plastic seat/back coloured at sight

code	finishing	q.kit	q.pack	a	b	c	d	kg.x1	vol.x1
134003-088	● nero/black	x1	10	450	440	500	300	1,62	mc. 0,012
134004-023	● grigio/grey ral7040	x1	10	450	440	500	300	1,62	mc. 0,012
134002-023	● rosso/red ppl42	x1	10	450	440	500	300	1,62	mc. 0,012
134015-023	● blu/blue rats002	x1	10	450	440	500	300	1,62	mc. 0,012
134007-023	● arancio/orange ppl22	x1	10	450	440	500	300	1,62	mc. 0,012
134005-023	● beige/beige ppl09	x1	10	450	440	500	300	1,62	mc. 0,012

20 pannello schienale da tappezzare
panel back for upholstery

code	finishing	q.kit	q.pack	a	b	kg.x1	vol.x1
132103-046	● nero/black	x1	20	390	310	0,50	mc. 0,004

21 pannello sedile da tappezzare
panel seat for upholstery

code	finishing	q.kit	q.pack	a	b	kg.x1	vol.x1
132203-046	● nero/black	x1	20	400	450	0,60	mc. 0,004

10 square-coppia braccioli in plastica
square-plastic pair arms

code	finishing	q.kit	q.pack	a	b	kg.x1	vol.x1
131703-005	● nero/black	x1	10	360	260	0,70	mc. 0,006
131704-005	● grigio/grey	x1	10	360	260	0,70	mc. 0,006

22 confezione viti tbl+ fr. d.5x14 per pannello da tappezzare
screws tbl+ fr.hilo d.5x14 zinc.black (to fix seat panel) package

code	finishing	q.kit	q.pack
117003-071	● nero/black	x4	200

27 doppia ruota 036 in pa (ricoperta pur)
pa twin wheel castor 036 (covered with pur)

code	finishing	q.kit
134403-001	● nero/black	x4

27 gambo godronato 08 zincato
zinc plated knured 08 stem

code	finishing	q.kit
117911-300	○ zincata/zinc	x4

14 **15** bracciolo destro/sinistro con gancio portatavoletta
right/left arm with attachment for tablet

code	finishing	q.kit	q.pack	kg.x1	vol.x1
131703-009	● nero/black	destra/right	x1	20	0,70 mc. 0,006
131703-006	● nero/black	sinistra/left	x1	20	0,70 mc. 0,006
131704-003	● grigio/grey	destra/right	x1	20	0,70 mc. 0,006
131704-004	● grigio/grey	sinistra/left	x1	20	0,70 mc. 0,006

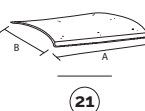
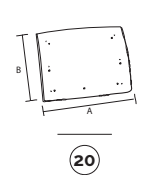
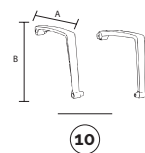
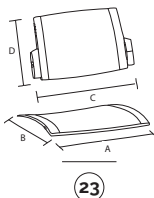
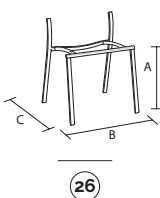

main component sizes

optional

square

4-legs for castors/backrest and seat options

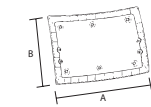

05

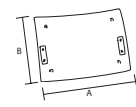

06



07



08

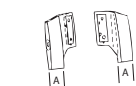

09



05 square-shi-schienale interno in plastica
square-shi-inner plastic back

code	finishing	q.kit	q.pack	a	b	kg.x1	vol.x1
132103-006	● nero/black	x1	20	440	290	0,55	mc. 0,004

06 square-she-schienale esterno in plastica
square-she-outer plastic back

code	finishing	q.kit	q.pack	a	b	kg.x1	vol.x1
132103-005	● nero/black	x1	20	425	280	0,37	mc. 0,004
132104-026	● grigio/grey	x1	20	425	280	0,37	mc. 0,004

07 square-sedile interno in plastica
square-inner plastic seat

code	finishing	q.kit	q.pack	a	b	kg.x1	vol.x1
132203-007	● nero/black	x1	20	440	460	0,90	mc. 0,005

08 square-sedile esterno in plastica
square-outer plastic seat

code	finishing	q.kit	q.pack	a	b	kg.x1	vol.x1
132203-006	● nero/black	x1	20	430	450	0,53	mc. 0,008
132204-026	● grigio/grey	x1	20	430	450	0,53	mc. 0,008

09 square-coppia supporti schienale in plastica
square-plastic pair of supports for back

code	finishing	q.kit	q.pack	a	kg.x1	vol.x1
134003-087	● nero/black	x1	40	25x15	0,16	mc. 0,0002
134004-022	● grigio/grey	x1	40	25x15	0,16	mc. 0,0002

and 11 12 04

main component sizes

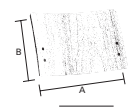

24

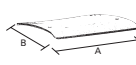

25



24 schienale in multistrato faggio + viti
back in plywood beech with screws

code	finishing	q.kit	q.pack	a	b	kg.x1
122107-010	● faggio/beech wood	x1	15	425	280	0,50

25 square sdlf-sedile multistrato faggio verniciato + viti
square sdlf-painted beech wood seat with screws

code	finishing	q.kit	q.pack	a	b	kg.x1
122207-015	● faggio/beech wood	x1	15	422	280	1,65

and 09 10 13

square

slide

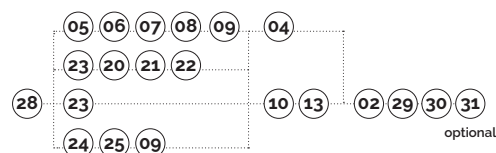

main component sizes

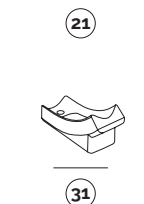
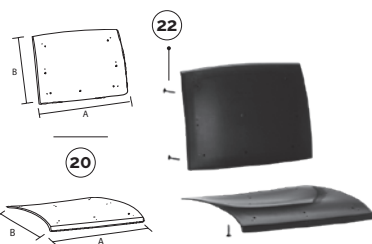
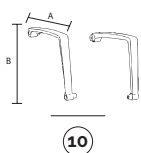
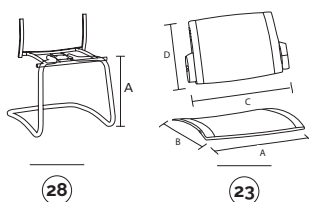

28 base slitta slide bases

code	finishing	q.kit	q.pack	a	kg.x1	vol.x1
110503-013	● nero/black	x1	80	450	6,50	mc. 0.03
110504-017	● grigio/grey	x1	80	450	6,50	mc. 0.03
110510-016	● cromato/chrome	x1	80	450	6,50	mc. 0.03

29 p2p pinza due pioli politene nera p2p two-pins plier in black polythene

code	finishing	q.kit
134003-003	● nero/black	x4

30 tappo copritesta alettato d.25 nero ribbed insert d.25 black

code	finishing	q.kit
134103-250	● nero/black	x2

31 piedino antiribaltamento in plastica nera plastic black feet anti-upsetting

code	finishing	q.kit	q.pack	a	b	kg.x1	vol.x1
134303-006	● nero/black	x2	100			0,025	mc. 0.0001

23 square-coppia sedile schienale in plastica colorato square-plastic seat/back coloured at sight

code	finishing	q.kit	q.pack	a	b	c	d	kg.x1	vol.x1
134003-088	● nero/black	x1	10	450	440	500	300	1,62	mc. 0.012
134004-023	● grigio/grey ral7040	x1	10	450	440	500	300	1,62	mc. 0.012
134002-023	● rosso/red ppl42	x1	10	450	440	500	300	1,62	mc. 0.012
134015-023	● blu/blue rat5002	x1	10	450	440	500	300	1,62	mc. 0.012
134007-023	● arancio/orange ppl22	x1	10	450	440	500	300	1,62	mc. 0.012
134005-023	● beige/beige ppl09	x1	10	450	440	500	300	1,62	mc. 0.012

20 pannello schienale da tappezzare panel back for upholstery

code	finishing	q.kit	q.pack	a	b	kg.x1	vol.x1
132103-046	● nero/black	x1	20	390	310	0,50	mc. 0.004

21 pannello sedile da tappezzare panel seat for upholstery

code	finishing	q.kit	q.pack	a	b	kg.x1	vol.x1
132203-046	● nero/black	x1	20	400	450	0,60	mc. 0.004

10 square-coppia braccioli in plastica square-plastic pair arms

code	finishing	q.kit	q.pack	a	b	kg.x1	vol.x1
131703-005	● nero/black	x1	10	360	260	0,70	mc. 0.006
131704-005	● grigio/grey	x1	10	360	260	0,70	mc. 0.006

22 confezione viti tbl+ fr. d.5x14 per pannello da tappezzare screws tbl+ fr.hilo d.5x14 zinc.black (to fix seat panel) package

code	finishing	q.kit	q.pack
117003-071	● nero/black	x4	200

02 puntale alettato rettangolare 25x15 ribbed rectangular insert 25x15

code	finishing	q.kit
134203-020	● nero/black	x2
134204-020	● grigio/grey	x2

04 tappo copritesta 022 per sedia senza braccioli cover head cap 022 for chair without arms

code	finishing	q.kit
134103-220	● nero/black	x2
134104-220	● grigio/grey	x2

square

slide/ backrest and seat options

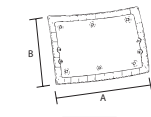

05

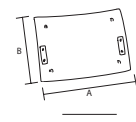

06

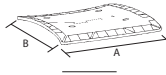

07

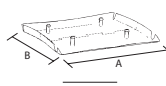

08

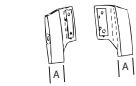

09



05 square-shi-schienale interno in plastica
square-shi-inner plastic back

code	finishing	q.kit	q.pack	a	b	kg.x1	vol.x1
132103-006	● nero/black	x1	20	440	290	0,55	mc. 0,004

06 square-she-schienale esterno in plastica
square-she-outer plastic back

code	finishing	q.kit	q.pack	a	b	kg.x1	vol.x1
132103-005	● nero/black	x1	20	425	280	0,37	mc. 0,004
132104-026	● grigio/grey	x1	20	425	280	0,37	mc. 0,004

07 square-sedile interno in plastica
square-inner plastic seat

code	finishing	q.kit	q.pack	a	b	kg.x1	vol.x1
132203-007	● nero/black	x1	20	440	460	0,90	mc. 0,005

08 square-sedile esterno in plastica
square-outer plastic seat

code	finishing	q.kit	q.pack	a	b	kg.x1	vol.x1
132203-006	● nero/black	x1	20	430	450	0,53	mc. 0,008
132204-026	● grigio/grey	x1	20	430	450	0,53	mc. 0,008

09 square-coppia supporti schienale in plastica
square-plastic pair of supports for back

code	finishing	q.kit	q.pack	a	kg.x1	vol.x1
134003-087	● nero/black	x1	40	25x15	0,16	mc. 0,0002
134004-022	● grigio/grey	x1	40	25x15	0,16	mc. 0,0002

and · 11 12 10 13 02

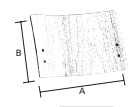

24

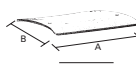

25



24 schienale in multistrato faggio + viti
back in plywood beech with screws

code	finishing	q.kit	q.pack	a	b	kg.x1
122107-010	● faggio/beech wood	x1	15	425	280	0,50

25 square sdlf-sedile multistrato faggio verniciato + viti
square sdlf-painted beech wood seat with screws

code	finishing	q.kit	q.pack	a	b	kg.x1
122207-015	● faggio/beech wood	x1	15	422	280	1,65

and · 09 04 02

main component sizes

square

swivel

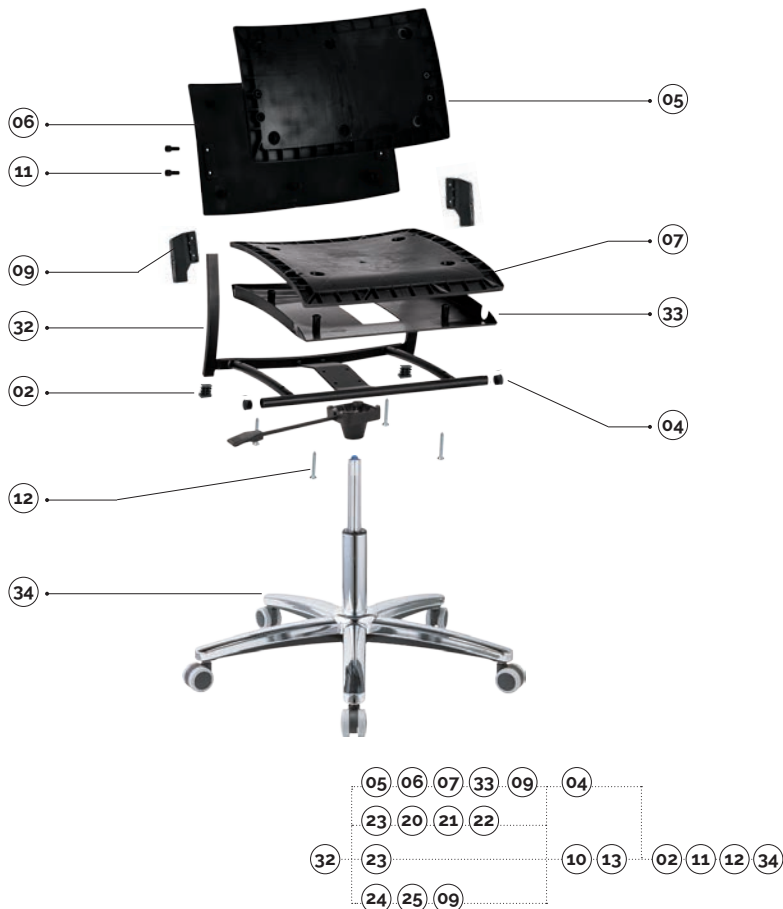

main component sizes

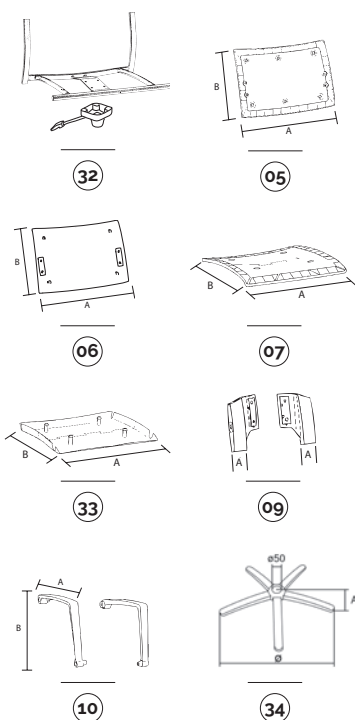

32 telaio girevole con blocchetto comando a gas
swivel frame gas with lever

code	finishing	q.kit	q.pack	kg.x1	vol.x1
112603-029	● nero/black	x1	100	3,50	mc. 0,05
112604-029	● grigio/grey	x1	100	3,50	mc. 0,05

02 puntale alettato rettangolare 25x15
ribbed rectangular insert 25x15

code	finishing	q.kit
134203-020	● nero/black	x2
134204-020	● grigio/grey	x2

04 tappo copritesta ø22 per sedia senza braccioli
cover head cap ø22 for chair without arms

code	finishing	q.kit
134103-220	● nero/black	x2
134104-220	● grigio/grey	x2

05 square-shi-schienale interno in plastica
square-shi-inner plastic back

code	finishing	q.kit	q.pack	a	b	kg.x1	vol.x1
132103-006	● nero/black	x1	20	440	290	0,55	mc. 0,004

06 square-she-schienale esterno in plastica
square-she-outer plastic back

code	finishing	q.kit	q.pack	a	b	kg.x1	vol.x1
132103-005	● nero/black	x1	20	425	280	0,37	mc. 0,004
132104-026	● grigio/grey	x1	20	425	280	0,37	mc. 0,004

07 square-sedile interno in plastica
square-inner plastic seat

code	finishing	q.kit	q.pack	a	b	kg.x1	vol.x1
132203-007	● nero/black	x1	20	440	460	0,90	mc. 0,005

33 square-sedile esterno in plastica
square-outer plastic seat

code	finishing	q.kit	q.pack	a	b	kg.x1	vol.x1
132203-008	● nero/black	x1	20	430	450	0,53	mc. 0,008
132204-027	● grigio/grey	x1	20	430	450	0,53	mc. 0,008

09 square-coppia supporti schienale in plastica
square-plastic pair of supports for back

code	finishing	q.kit	q.pack	a	kg.x1	vol.x1
134003-087	● nero/black	x1	40	25x15	0,16	mc. 0,0002
134004-022	● grigio/grey	x1	40	25x15	0,16	mc. 0,0002

10 square-coppia braccioli in plastica
square-plastic pair arms

code	finishing	q.kit	q.pack	a	b	kg.x1	vol.x1
131703-005	● nero/black	x1	10	360	260	0,70	mc. 0,006
131704-005	● grigio/grey	x1	10	360	260	0,70	mc. 0,006

11 vite testa cilindrica a croce m6x16 zincata
screw cylindrical cross head m6x16 zinc

code	finishing	q.kit
117711-191	○ zincata/zinc	x4

12 vite testa svasata a croce m6x30 zincata (vite per fissaggio sedile)
screw flared head m6x30 zinc (screw for six seat)

code	finishing	q.kit
117711-192	○ zincata/zinc	x4

34 b40 base in metallo d.640 con coprisaldatura
b40 metal base d.640 with cover welding

code	finishing	q.kit	q.pack	a	ø	kg.x1	vol.x1
110210-027	● cromato/chrome	x1	5	60	640	2,85	mc. 0,014

square

swivel/backrest and seat options

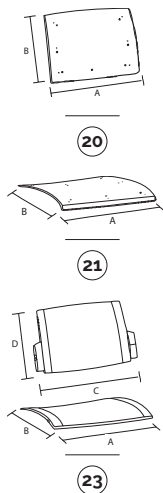

23 square-coppia sedile schienale in plastica colorato square-plastic seat/back coloured at sight

code	finishing	q.kit	q.pack	a	b	c	d	kg.x1	vol.x1
134003-088	● nero/black	x1	10	450	440	500	300	1.62	mc. 0,012
134004-023	● grigio/grey RAL7040	x1	10	450	440	500	300	1.62	mc. 0,012
134002-023	● rosso/red PPL42	x1	10	450	440	500	300	1.62	mc. 0,012
134015-023	● blu/blue RAL5002	x1	10	450	440	500	300	1.62	mc. 0,012
134007-023	● arancio/orange PPL22	x1	10	450	440	500	300	1.62	mc. 0,012
134005-023	● beige/beige PPL09	x1	10	450	440	500	300	1.62	mc. 0,012

20 pannello schienale da tappezzare panel back for upholstery

code	finishing	q.kit	q.pack	a	b	kg.x1	vol.x1
132103-046	● nero/black	x1	20	390	310	0,50	mc. 0,004

21 pannello sedile da tappezzare panel seat for upholstery

code	finishing	q.kit	q.pack	a	b	kg.x1	vol.x1
132203-046	● nero/black	x1	20	400	450	0,60	mc. 0,004

22 confezione viti tbl+ fr. d.5x14 per pannello da tappezzare screws tbl+ fr.hilo d.5x14 zinc.black (to fix seat panel) package

code	finishing	q.kit	q.pack
117003-071	● nero/black	x4	200

and - 04 02

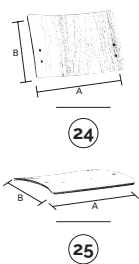

24 schienale in multistrato faggio + viti back in plywood beech with screws

code	finishing	q.kit	q.pack	a	b	kg.x1
122107-010	● faggio/beech wood	x1	15	425	280	0,50

25 square sdlf-sedile multistrato faggio verniciato + viti square sdlf-painted beech wood seat with screws

code	finishing	q.kit	q.pack	a	b	kg.x1
122207-015	● faggio/beech wood	x1	15	422	280	1,65

and - 09 04 02

square bench

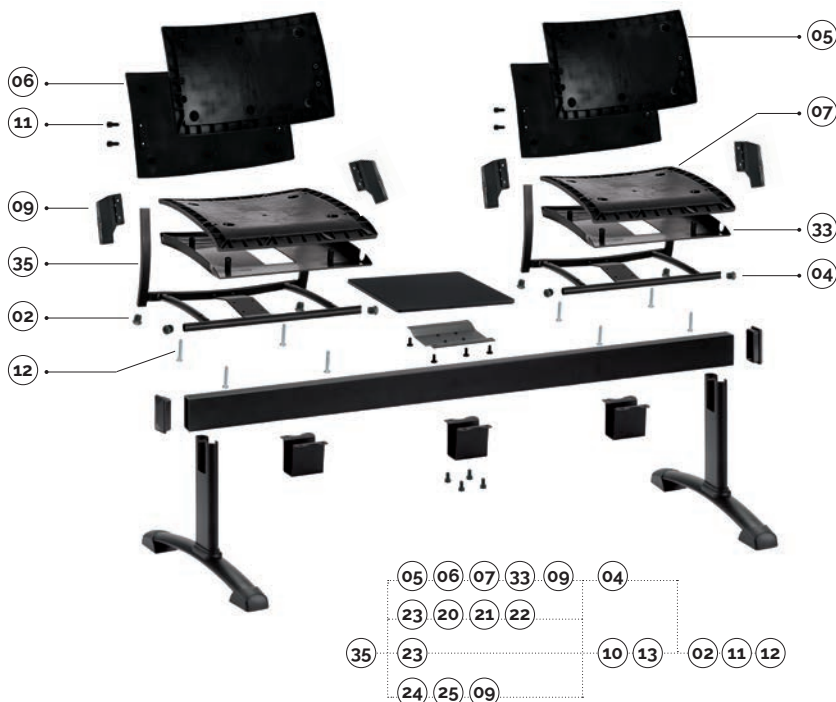

main component sizes



35

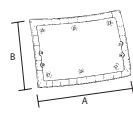

05

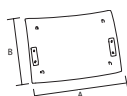

06

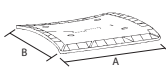

07

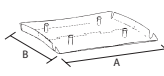

33



09

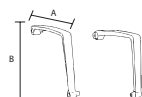

10

35 square.p telaio per panca tappi esclusi
square.p bench frame caps excluded

code	finishing	q.kit	q.pack	kg.x1	vol.x1
110703-050	● nero/black	x1	100	2.80	mc. 0.020
110704-063	● grigio/grey	x1	100	2.80	mc. 0.020

02 puntale alettato rettangolare 25x15
ribbed rectangular insert 25x15

code	finishing	q.kit
134203-020	● nero/black	x2
134204-020	● grigio/grey	x2

04 tappo copritesta 022 per sedia senza braccioli
cover head cap 022 for chair without arms

code	finishing	q.kit
134103-220	● nero/black	x2
134104-220	● grigio/grey	x2

05 square-shi-schienale interno in plastica
square-shi-inner plastic back

code	finishing	q.kit	q.pack	a	b	kg.x1	vol.x1
132103-006	● nero/black	x1	20	440	290	0.55	mc. 0.004

06 square-she-schienale esterno in plastica
square-she-outer plastic back

code	finishing	q.kit	q.pack	a	b	kg.x1	vol.x1
132103-005	● nero/black	x1	20	425	280	0.37	mc. 0.004
132104-026	● grigio/grey	x1	20	425	280	0.37	mc. 0.004

07 square-sedile interno in plastica
square-inner plastic seat

code	finishing	q.kit	q.pack	a	b	kg.x1	vol.x1
132203-007	● nero/black	x1	20	440	460	0.90	mc. 0.005

33 square-sedile esterno in plastica
square-outer plastic seat

code	finishing	q.kit	q.pack	a	b	kg.x1	vol.x1
132203-008	● nero/black	x1	20	430	450	0.53	mc. 0.008
132204-027	● grigio/grey	x1	20	430	450	0.53	mc. 0.008

09 square-coppia supporti schienale in plastica
square-plastic pair of supports for back

code	finishing	q.kit	q.pack	a	kg.x1	vol.x1
134003-087	● nero/black	x1	40	25x15	0.16	mc. 0.0002
134004-022	● grigio/grey	x1	40	25x15	0.16	mc. 0.0002

10 square-coppia braccioli in plastica
square-plastic pair arms

code	finishing	q.kit	q.pack	a	b	kg.x1	vol.x1
131703-005	● nero/black	x1	10	360	260	0.70	mc. 0.006
131704-005	● grigio/grey	x1	10	360	260	0.70	mc. 0.006

11 vite testa cilindrica a croce m6x16 zincata
screw cylindrical cross head m6x16 zinc

code	finishing	q.kit
117711-191	○ zincata/zinc	x4

12 vite testa svasata a croce m6x30 zincata (vite per fissaggio sedile)
screw flared head m6x30 zinc (screw for six seat)

code	finishing	q.kit
117711-192	○ zincata/zinc	x4

for the bench components, see page 249

OPTIONAL
bench
connector

E-USB **NEW**
bench plug



JIM **NEW**
bench leg

APOLL
bench arm



plastic

90GM
bench leg

90GF
bench leg

100GM
bench leg

200GM
bench leg

PIONEER
bench arm



metal

CUT
bench leg

SLIM
bench leg

CUT
bench arm

SLIM
bench arm



aluminium

optionals

square

bench/backrest and seat options

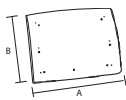

20

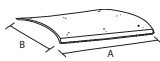

21

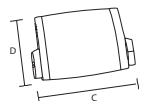

23



23 square-coppia sedile schienale in plastica colorato square-plastic seat/back coloured at sight

code	finishing	q.kit	q.pack	a	b	c	d	kg.x1	vol.x1
134003-088	● nero/black	x1	10	450	440	500	300	1.62	mc. 0,012
134004-023	● grigio/grey RAL7040	x1	10	450	440	500	300	1.62	mc. 0,012
134002-023	● rosso/red PPL42	x1	10	450	440	500	300	1.62	mc. 0,012
134015-023	● blu/blue RAL5002	x1	10	450	440	500	300	1.62	mc. 0,012
134007-023	● arancio/orange PPL22	x1	10	450	440	500	300	1.62	mc. 0,012
134005-023	● beige/beige PPL09	x1	10	450	440	500	300	1.62	mc. 0,012

20 pannello schienale da tappezzare panel back for upholstery

code	finishing	q.kit	q.pack	a	b	kg.x1	vol.x1
132103-046	● nero/black	x1	20	390	310	0,50	mc. 0,004

21 pannello sedile da tappezzare panel seat for upholstery

code	finishing	q.kit	q.pack	a	b	kg.x1	vol.x1
132203-046	● nero/black	x1	20	400	450	0,60	mc. 0,004

22 confezione viti tbl+ fr. d.5x14 per pannello da tappezzare screws tbl+ fr.hilo d.5x14 zinc.black (to fix seat panel) package

code	finishing	q.kit	q.pack
117003-071	● nero/black	x4	200

and · 04 02

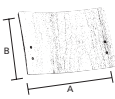

24

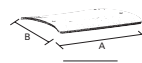

25



24 schienale in multistrato faggio back in plywood beech

code	finishing	q.kit	q.pack	a	b	kg.x1
122107-010	● faggio/beech wood	x1	15	425	280	0,50

25 square sdlf-sedile multistrato faggio verniciato + viti square sdlf-painted beech wood seat with screws

code	finishing	q.kit	q.pack	a	b	kg.x1
122207-015	● faggio/beech wood	x1	15	422	280	1,65

and · 09 04 02