



BEYOND **Design**





wing



wing



slide

4-legs
wooden 4-legs

swivel

bench

wing showing

tools



configurator



brochure



video

features



designed by:
shannon sadler



outdoor
ready



Wing, 3 grandi vantaggi in una seduta.

Design distintivo e massimo comfort grazie soprattutto alle due caratteristiche ali. Estremamente funzionale e versatile prevede 5 varianti colore della monoscocca e diversi telai e accessori opzionabili.

Plus:

- grande impatto estetico, grazie al suo design distintivo;
- estremo comfort, grazie alla generosa monoscocca;
- facile da pulire e da spostare.

Wing è la nuova proposta di seduta per l'ambiente Contract e l'ambiente Home.

Wing: 3 great advantages in one chair.

Distinctive design and maximum comfort thanks in particular to the two characteristic wings. Extremely functional and versatile, available in 5 colour variants for the monocoque and various options for frames and accessories.

Advantages:

- great aesthetic impact, thanks to its distinctive design;
- outstanding comfort, thanks to the generous monocoque;
- easy to clean and move.

Wing is the new chair designed for Contract and Home environments.

wing

slide



plastic colours

- avorio/ivory ral1013
- corallo/coral 1797u
- nocciola/hazelnut 2312u
- nero/black ral9005
- blu/blue 541u

01 02 03 04 05 07 08
optional

main component sizes

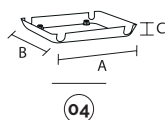
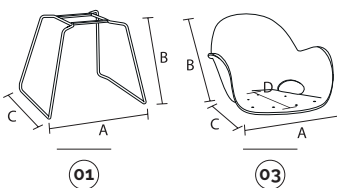

optional

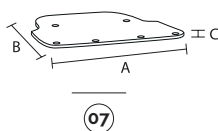

01 telaio a slitta in tondino d.12 slide wire frame d.12

code	finishing	q.kit	q.pack	a	b	c	kg.x1	vol.x1
113407-400	● ramato/copper	x1	100	540	525	440	3,54	mc. 0,026
113410-400	● cromato/chrome						3,54	mc. 0,026

02 confezione di basi a pinza antirotazione per tondino colore neutro neutral clips base for wire d.11 package

code	finishing	q.kit	q.pack
137006-070	○ neutro/neutral	x4	200

03 scocca a pozzetto con braccioli (anti-uv) plastic shell with arms (anti-uv)

code	finishing	q.kit	q.pack	a	b	c	d	kg.x1	vol.x1
133905-042	● avorio/ivory ral1013	x1	5	570	430	590	410	2,9	mc. 0,041

04 copertina in plastica (anti-uv) plastic cover (anti-uv)

code	finishing	q.kit	a	b	c	kg.x1
132205-039	● avorio/ivory ral1013	x1	265	250	40	0,15

05 vite tsp+ m6x25 zincata bianca (vite per fissaggio scocca con copertina) x 4g sl cv pc gir screw tsp+ m6x25 white zinc (screw for fix shell with cover)

code	finishing	q.kit
117711-199	● zincata bianca/white zinc	x4

07 pannello sedile multistrato plywood seat panel

code	finishing	q.kit	q.pack	a	b	c	kg.x1	vol.x1
122207-023	● faggio/plywood	x1	20	376	370	5	0,3	mc. 0,0019

08 vite tbcl m4x10 zincata bianca (vite per fissaggio pannello sedile) screw tbcl m4x10 white zinc (screw for fix seat panel)

code	finishing	q.kit
117703-124	● zincata bianca/white zinc	x6



for all colour codes, see page 37

wing

slide

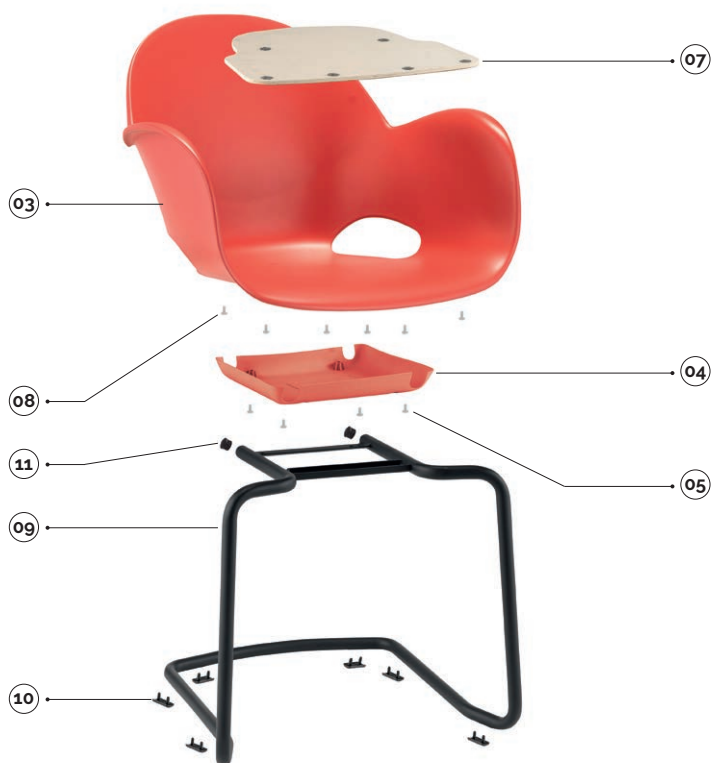

09 10 03 04 05 07 08 11
optional

plastic colours

- avorio/ivory ral1013
- corallo/coral 1797u
- nocciola/hazelnut 2312u
- nero/black ral9005
- blu/blue 541u

main component sizes

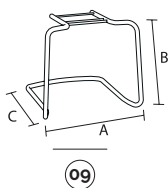

09 base a slitta in tubo d.22 senza tappi
cantilever frames d.22 without caps

code	finishing	q.kit	q.pack	a	b	c	kg.x1	vol.x1
110503-480	● nero/black	x1	64	510	450	500	3,77	mc. 0.0313
110505-480	● avorio/ivory ral1013	x1	64	510	450	500	3,77	mc. 0.0313
110504-480	● grigio/grey	x1	64	510	450	500	3,77	mc. 0.0313
110510-480	● cromato/chrome	x1	64	510	450	500	3,77	mc. 0.0313

10 pinza due pioli in polietilene nera
two pins pliers in black polythene

code	finishing	q.kit	kg.x1
134003-003	● nero/black	x6	0,05

11 tappo copritesta ø22 per cantilever
cover head cap ø22 for cantilever

code	finishing	q.kit
134103-220	● nero/black	x2
134104-220	● grigio/grey	x2

for the components below, see page 30

03 04 05 07 08



for all colour codes, see page 37

wing

4-legs



plastic colours

- avorio/ivory ral1013
- corallo/coral 1797u
- nocciola/hazelnut 2312u
- nero/black ral9005
- blu/blue 541u

main component sizes

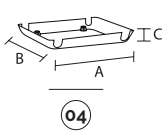
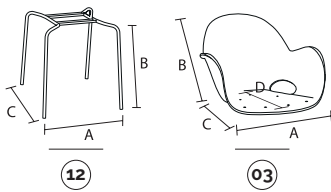

optional

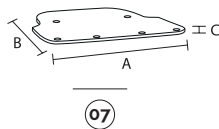

12 13 03 04 05 07 08
optional

12 telaio 4 gambe d.16 senza tappi 4 legs frames d.16 without caps

code	finishing	q.kit	q.pack	a	b	c	kg.x1	vol.x1
110603-613	● nero/black	x1	200	415	445	520	2,05	mc. 0,014
110605-613	● avorio/ivory ral1013	x1	200	415	445	520	2,05	mc. 0,014
110604-613	● grigio/grey	x1	200	415	445	520	2,05	mc. 0,014
110607-613	● ramato/copper	x1	200	415	445	520	2,05	mc. 0,014
110610-613	● cromato/chrome	x1	200	415	445	520	2,05	mc. 0,014
110603-614	● nero/black 'per esterno/outdoor	x1	200	415	445	520	2,05	mc. 0,014
110605-614	● avorio/ivory ral1013 'per esterno/outdoor	x1	200	415	445	520	2,05	mc. 0,014
110604-614	● grigio/grey 'per esterno/outdoor	x1	200	415	445	520	2,05	mc. 0,014

13 puntale alettato tondo d.16 nero inner cap for legs d.16 black

code	finishing	q.kit
134203-160	● nero/black	x4

03 scocca a pozzetto con braccioli (anti-uv) plastic shell with arms (anti-uv)

code	finishing	q.kit	q.pack	a	b	c	d	kg.x1	vol.x1
133905-042	● avorio/ivory ral1013	x1	5	570	430	590	410	2,9	mc. 0,041

04 copertina in plastica (anti-uv) plastic cover (anti-uv)

code	finishing	q.kit	a	b	c	kg.x1
132205-039	● avorio/ivory ral1013	x1	265	250	40	0,15

05 vite tsp+ m6x25 zincata bianca (vite per fissaggio scocca con copertina) x 4g sl cv pc gir screw tsp+ m6x25 white zinc (screw for fix shell with cover)

code	finishing	q.kit
117711-199	● zincata bianca/white zinc	x4

07 pannello sedile multistrato plywood seat panel

code	finishing	q.kit	q.pack	a	b	c	kg.x1	vol.x1
122207-023	● faggio/plywood	x1	20	376	370	5	0,3	mc. 0,0019

08 vite tbcl m4x10 zincata bianca (vite per fissaggio pannello sedile) screw tbcl m4x10 white zinc (screw for fix seat panel)

code	finishing	q.kit
117703-124	● zincata bianca/white zinc	x6



for all colour codes, see page 37

wing

wooden 4-legs



plastic colours

- avorio/ivory ral1013
- corallo/coral 1797u
- nocciola/hazelnut 2312u
- nero/black ral9005
- blu/blue 541u

14 03 15 07 08
optional

main component sizes

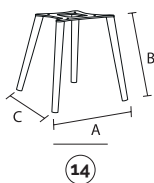

14 kit 4 gambe legno massello faggio trasparente + piastra in metallo
kit beechwood 4 legs frames with metal plate

code	finishing	plate colour	q.kit	a	b	c
120107-000	● faggio/beechwood	nero/black	x1	420	440	490
120107-001	● faggio/beechwood	bianco/white	x1	420	440	490

15 vite tbl combi m6x16 dentell, zinc. bianca (vite per fissaggio scocca senza copertina) legno
screw tbl combi m6x16 white zinc (screw for fix shell without cover) wooden 4-legs

code	finishing	q.kit
117711-191	● zincata bianca/white zinc	x4

for the components below, see page 32

03 07 08



for all colour codes, see page 37

wing

swivel



plastic colours

- avorio/ivory ral1013
- corallo/coral 1797u
- nocciola/hazelnut 2312u
- nero/black ral9005
- blu/blue 541u

main component sizes

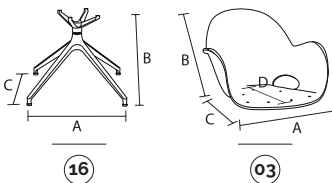

optional

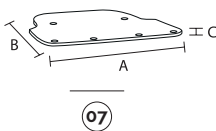

16 03 06 07 08
optional

16 base 4 razze d720 in alluminio
high aluminium base d.720

code	finishing	q.kit	q.pack	a	b	c	kg.x1
110210-090	● alluminio/aluminium	x1	6	515	415	515	4.03

03 scocca a pozzetto con braccioli (anti-uv)
plastic shell with arms (anti-uv)

code	finishing	q.kit	q.pack	a	b	c	d	kg.x1	vol.x1
133903-040	● nero/black ral9005	x1	5	570	430	590	410	2.9	mc. 0.041

06 vite t6l combi m6x12 dentell. zincata bianca (vite per fissaggio scocca senza copertina) 4g sl cv pc gir
screw t6l combi m6x12 white zinc (screw for fix shell without cover)

code	finishing	q.kit
117711-206	● zincata bianca/white zinc	x4

07 pannello sedile multistrato
plywood seat panel

code	finishing	q.kit	q.pack	a	b	c	kg.x1	vol.x1
122207-023	● faggio/plywood	x1	20	376	370	5	0.3	mc. 0.0019

08 vite t6cl m4x10 zincata bianca (vite per fissaggio pannello sedile)
screw t6cl m4x10 white zinc (screw for fix seat panel)

code	finishing	q.kit
117703-124	● zincata bianca/white zinc	x6



for all colour codes, see page 37

wing

swivel



plastic colours

- avorio/ivory ral1013
- corallo/coral 1797u
- nocciola/hazelnut 2312u
- nero/black ral9005
- blu/blue 541u

main component sizes

optionals

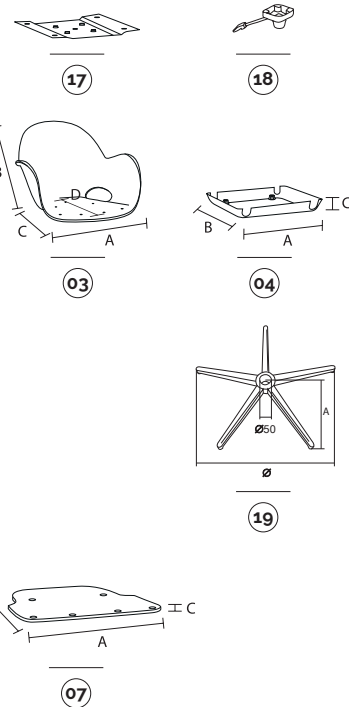

17 03 18 04 05 07 08 19
optional

17 g2p(01) gnr - piastra per girevole nera
g2p(01) gnr - plate for swivel black

code	finishing	q.kit	q.pack	kg.x1	vol.x1
110903-000	● nero/black	x1	25	0,85	mc. 0.0008

18 blocchetto in alluminio 0' d.28 x gas con leva nero opaco
black alu block 0' d.28 x gas with lever

code	finishing	q.kit	q.pack	kg.x1	vol.x1
110903-100	● nero/black	x1	1	0,305	mc. 0.0225

03 scocca a pozzetto con braccioli (anti-uv)
plastic shell with arms (anti-uv)

code	finishing	q.kit	q.pack	a	b	c	d	kg.x1	vol.x1
133915-042	● blu/blue 541u	x1	5	570	430	590	410	2,9	mc. 0.041

04 copertina in plastica (anti-uv)
plastic cover (anti-uv)

code	finishing	q.kit	a	b	c	kg.x1
132215-039	● blu/blue 541u	x1	265	250	40	0,15

05 vite tsp+ m6x25 zincata bianca (vite per fissaggio scocca con copertina) x 4g sl cv pc gir
screw tsp+ m6x25 white zinc (screw for fix shell with cover)

code	finishing	q.kit
117711-199	● zincata bianca/white zinc	x4

07 pannello sedile multistrato con 6 borchie m4
seat panel with 6 upholstery nail m4

code	finishing	q.kit	q.pack	a	b	c	kg.x1	vol.x1
122207-023	● faggio/plywood	x1	20	376	370	5	0,3	mc. 0.0019

08 vite tbcl m4x10 zincata bianca (vite per fissaggio pannello sedile)
screw tbcl m4x10 white zinc (screw for fix seat panel)

code	finishing	q.kit
117703-124	● zincata bianca/white zinc	x6

19 base in metallo d.640 con coprisaldatura
metal base d.640 with cover welding

code	finishing	q.kit	q.pack	ø	a	kg.x1	vol.x1
110210-057	● cromato/chrome	x1	5	640	112	2,25	mc. 0.0117



for all colour codes, see page 37

wing

bench

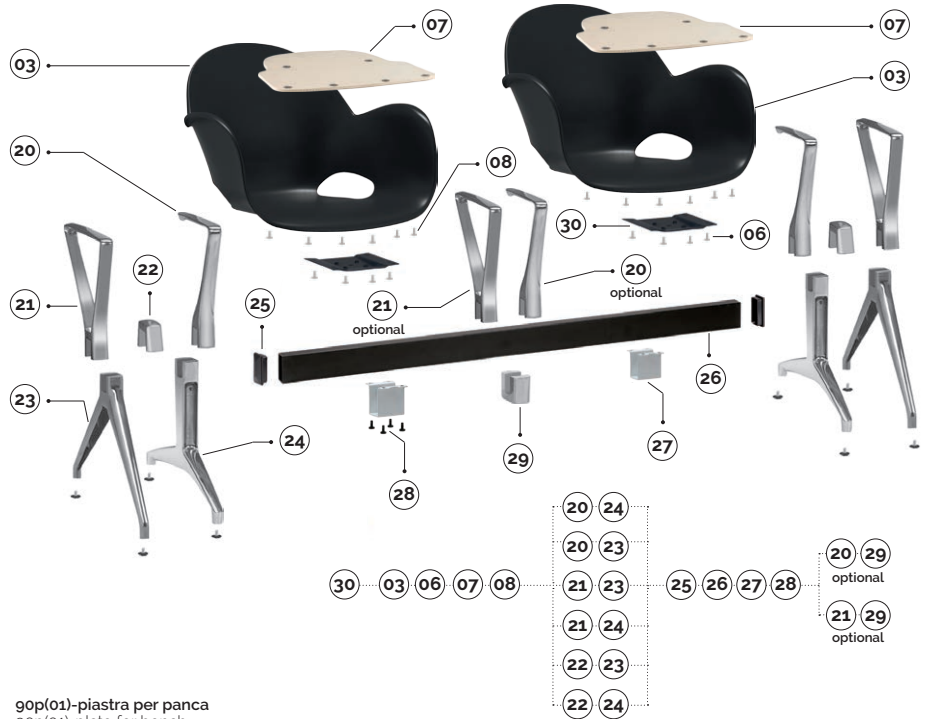

plastic colours

- avorio/ivory ral1013
- corallo/coral 1797u
- nocciola/hazelnut 2312u
- nero/black ral9005
- blu/blue 541u



30

main component sizes



20

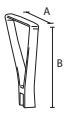

21

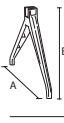

22

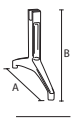

23

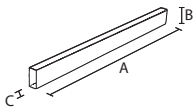

26

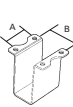

27



22



29

for the components below, see page 34

03 06 07 08

for the bench components, see page 249

30 90p(01)-piastra per panca
90p(01)-plate for bench

code	finishing	q.kit	q.pack	kg.x1	vol.x1
110703-013	● nero/black	x1	25	0,85	mc. 0,0008
110704-078	● grigio/grey	x1	25	0,85	mc. 0,0008

20 cut-bracciolo in alluminio per panca + n'2 viti
cut-aluminium arm for bench + n'2 screw

code	finishing	q.kit	q.pack	a	b	kg.x1	vol.x1
111704-223	● alluminio/aluminium	x1	10	300	305	1,40	mc. 0,0011

21 slim-bracciolo in alluminio per panca + n'2 viti
slim-aluminium arm for bench + n'2 screw

code	finishing	q.kit	q.pack	a	b	kg.x1	vol.x1
111704-225	● alluminio/aluminium	x1	10	325	305	1,40	mc. 0,0011

22 cut/slim-cavallotto in alluminio per gamba panca + n'2 viti
cut/slim-aluminium bracket 80x40 for bench leg + n'2 screw

code	finishing	q.kit	q.pack	kg.x1	vol.x1
111704-222	● alluminio/aluminium	x1	10	0,40	mc. 0,0012

23 slim-gamba in alluminio per panca
slim-aluminium leg for bench

code	finishing	q.kit	q.pack	a	b	kg.x1	vol.x1
111704-226	● alluminio/aluminium	x2	5	610	350	1,20	mc. 0,014

24 cut-gamba in alluminio per panca
cut-aluminium leg for bench

code	finishing	q.kit	q.pack	a	b	kg.x1	vol.x1
111704-224	● alluminio/aluminium	x2	5	610	350	2,55	mc. 0,014

25 tappo copritesta rettangolare 80x40 nero
rectangular cover head cap 80x40 black

code	finishing	q.kit
134103-001	● nero/black	x2

26 90t(03) trave per panca 80x40
90t(03) beam for bench 80x40

code	finishing	q.kit	q.pack	a	b	c	kg.x1	vol.x1	
110703-190	● nero/black	2 posti / 2 seats	x1	1	1160	80	40	3,20	mc. 0,0045
110704-190	● grigio/grey	2 posti / 2 seats	x1	1	1160	80	40	3,20	mc. 0,0045
110703-191	● nero/black	3 posti / 3 seats	x1	1	1710	80	40	4,71	mc. 0,005
110704-191	● grigio/grey	3 posti / 3 seats	x1	1	1710	80	40	4,71	mc. 0,005
110703-192	● nero/black	4 posti / 4 seats	x1	1	2260	80	40	6,22	mc. 0,0085
110704-192	● grigio/grey	4 posti / 4 seats	x1	1	2260	80	40	6,22	mc. 0,0085
110703-193	● nero/black	5 posti / 5 seats	x1	1	2800	80	40	7,72	mc. 0,01
110704-197	● grigio/grey	5 posti / 5 seats	x1	1	2800	80	40	7,72	mc. 0,01

27 90cv-cavallotto sotto trave
90cv-support under beam

code	finishing	q.kit	q.pack	a	b	kg.x1	vol.x1
110703-007	● nero/black	x1	50	55	65	0,60	mc. 0,0005
110704-016	● grigio/grey	x1	50	55	65	0,60	mc. 0,0005

28 confezione viti m8x12 testa cilindrica a esagono incassato brunita nera
screws m8x12 cylindrical head hexagon embedded burnishing black package

code	finishing	q.kit	q.pack
117003-070	● nero/black	x4	200

29 cut/slim-cavallotto in alluminio per bracciolo panca
cut/slim-aluminium bracket 80x40 for bench arm

code	finishing	q.kit	q.pack	kg.x1	vol.x1
111704-221	● alluminio/aluminium	x1	10	0,32	mc. 0,0012

optionals

OPTIONAL bench connector E-USB NEW bench plug



JIM NEW APOLL bench leg bench arm



plastic

90GM 90GF 100GM 200GM bench leg bench leg bench leg bench leg



metal

PIONEER bench arm



CUT SLIM CUT SLIM bench leg bench leg bench arm bench arm



aluminium

wing

optional colour codes



plastic colour codes



03 scocca a pozzetto con braccioli (anti-uv)
plastic shell with arms (anti-uv)

- 133905-042 avorio/ivory ral1013
- 133902-042 corallo/coral 1797u
- 133907-042 nocciola/hazelnut 2312u
- 133903-040 nero/black ral9005
- 133915-042 blu/blue 541u



04 copertina in plastica (anti-uv)
plastic cover (anti-uv)

- 132205-039 avorio/ivory ral1013
- 132202-039 corallo/coral 1797u
- 132207-039 nocciola/hazelnut 2312u
- 132203-039 nero/black ral9005
- 132215-039 blu/blue 541u

